



Deactivating your DM100i and installing your NEW

DM125TM Postage Meter



Step 1. Deactivate Your DM100i System

i Important: For best results, we strongly encourage you to follow the steps in this guide in [sequential order](#).

1. Print a Postage Funds Report (Postage)

- A. Press Funds
- B. Press “Page down” to the third screen
- C. Select print funds report
- D. Insert envelope or tape sheet into machine when prompted

Funds Report	Used:	\$464 . 270		JAN 07 16
	Available:	\$000 . 000	Batch Count:	733
	Total Pieces:	735	Batch Value:	\$464 . 270
	Control Sum:	\$464 . 270	PBP Serial No.:	0011969
				9:55P

2. Print Accounts Report (if using accounting)

- A. Press reports
- B. Select “printable report”
- C. Select “multi acct summary”
- D. When Prompted, insert tape sheet or envelope into machine (note if it is a multi-page report, you will be prompted to insert another envelope/tape sheet)

Accounts Summary	Account No.	Pieces	Postage	0000011969
	1	5	001 . 480	JAN 15 16
	2	4	001 . 480	11 : 04A
				page 1 of 1

3. Withdraw Postage Funds From the DM100i and Transfer to Your Postage Account

- A. Verify that your DM100i is turned on and is connected to the Pitney Bowes Data Centre by USB (if using computer with PC Meter Connect).
- B. Press Options
- C. Press Page Down twice
- D. Select “Advance Features”

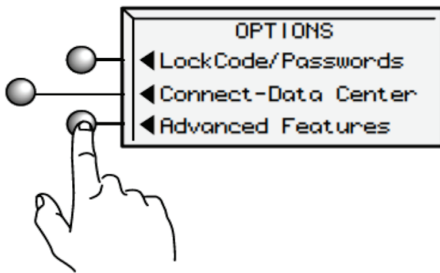

- E. Select “Meter Withdrawal”

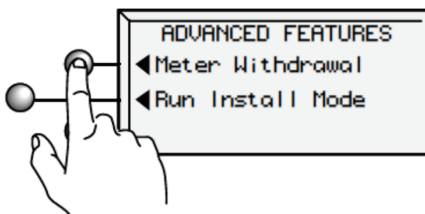

- F. Select “Transfer all funds from meter to PBP account”

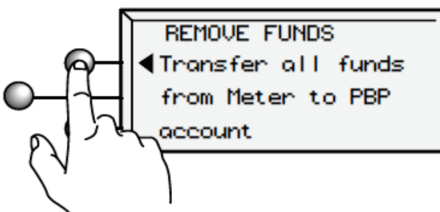

- G. The system dials into the Pitney Bowes Data Centre (this may take a few moments). Various screens display, letting you know the status of the process.
- H. The Transfer Successful screen displays. Select “Continue”
- I. Meter will show: “System out of Service”.
- J. Any funds Left on your meter due to meter error or defect will be refunded once the meter is returned and processed. Expect 4-6 Weeks For the Refund. Funds advance can be arranged so you don't experience any down time.

4. Disassemble Your Old System

Remove Ink

A. Open top cover and the Replace Ink Cartridge screen will display:

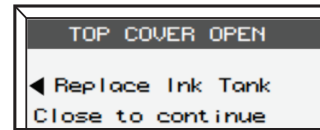

B. Select "Replace ink tank"

C. When the printing mechanism has moved forward, open the ink cartridge guard and remove the ink cartridge. This ink cartridge will be installed in your new DM125 system.

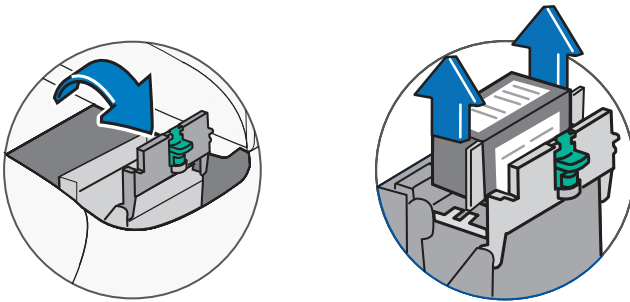

D. Close the Ink cartridge guard, and close the meter top cover.

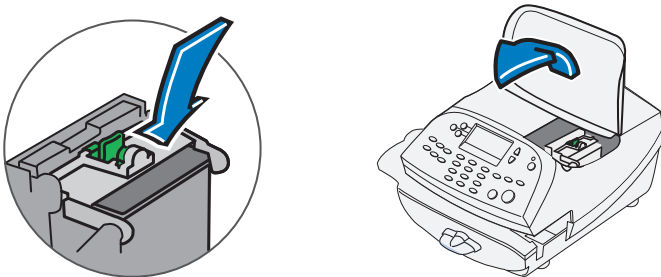

E. Wait five seconds and then disconnect the power and USB cords from the back of the meter.

Remove Moistener and Scale

A. If your unit has the moistener, remove it by pushing down the blue release lever and pulling it straight out to the left. Remove the scale by lifting it away from the meter.

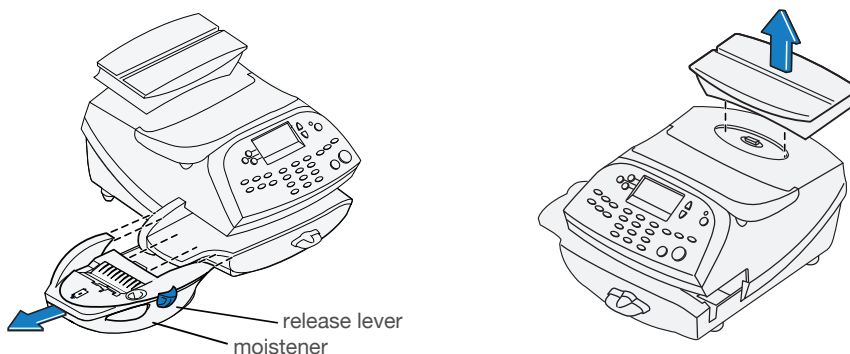

Step 2. Installing Your NEW DM125 system

1. Verify Contents of NEW Mailing System Package

Mailing System

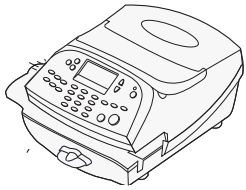

Scale (optional)

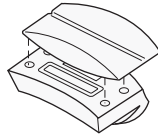

Stacker

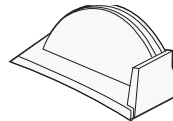

Moistener and EZ-Seal (optional)



Pitney Bowes Ink Cartridge (Re-order #739-5)

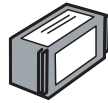

Print Head in Package



Tape Sheets

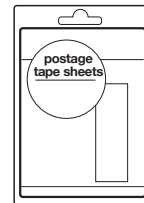

USB Cable

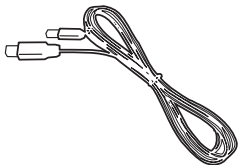

LAN Cable & Adapter

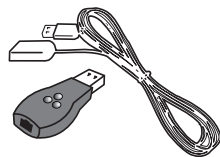

Power Cord



Quick Install Guide



Basics Poster



2. Remove Shipping Tape

Open the top cover of the meter and remove any packing material, protective foam, tape that may be present. After done you can close the cover.

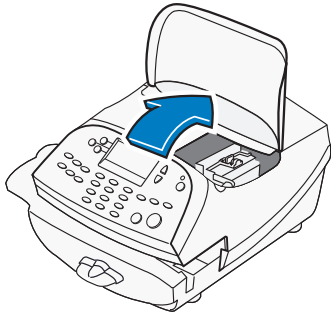

3. Install Additional Components

A. Scale

If your system came with the optional scale, attach it now. The scale consists of two pieces. Place the platform on top of the base unit, being sure the pegs on the platform are inserted into the corresponding holes in the base unit.

Position the assembled scale as shown. Now plug the connector on the bottom of the base unit into the matching connector on your system.

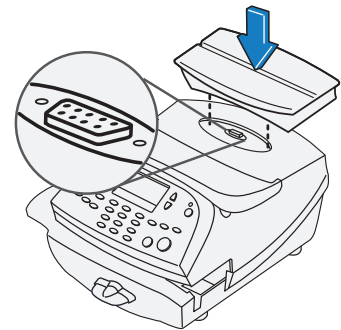
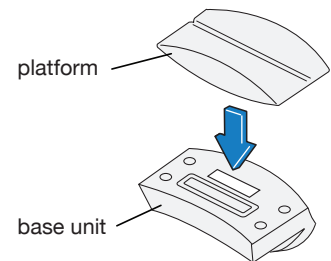

B. Moistener

The optional moistener allows you to moisten, seal, and apply postage to your envelopes all in one smooth step. Position the moistener on the left side of the deck as shown. Hold down the blue release lever and slide moistener from left to right, with the lip of the moistener above the deck.

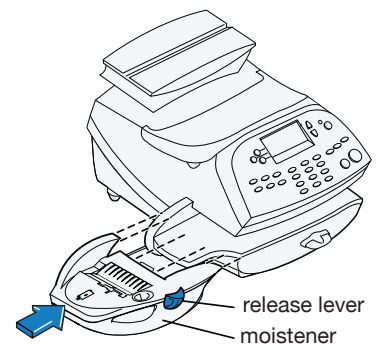

Step 3. Select a Connection Method

Your system must connect to the Pitney Bowes Data Centre to add funds that were returned from the old system and to download updates. Your new meter can be connected using PC Meter Connect® or LAN adapter. Read options first, then choose the appropriate connection method.

Option 1: Setup Connectivity Using PC Meter Connect

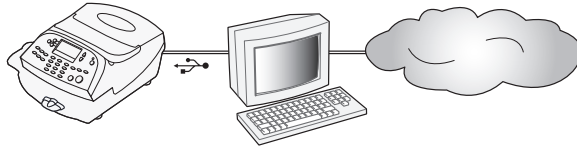

1. Go to <http://www.pitneybowes.ca/support/> to download PC Meter Connect™ software. Select to run or save the software and open the file and follow the install Prompts.

Screen 1



Screen 2

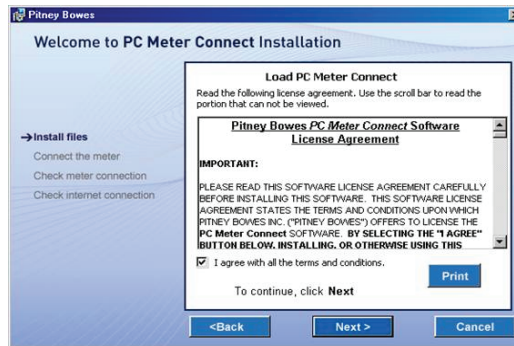

Screen 3

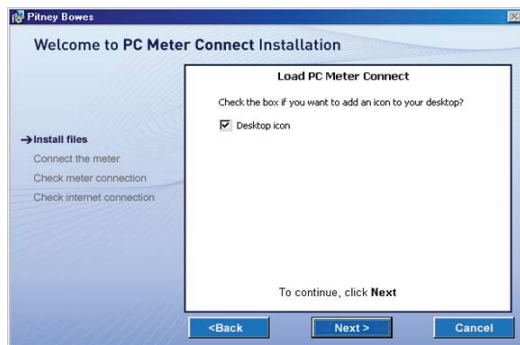

Screen 4

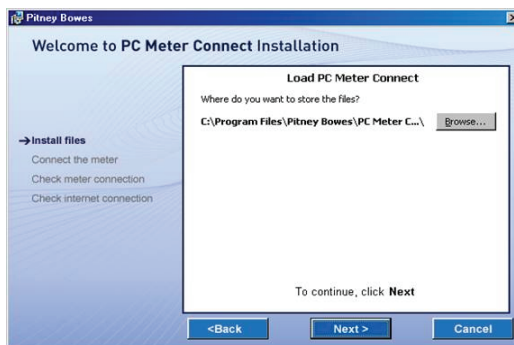

Screen 5

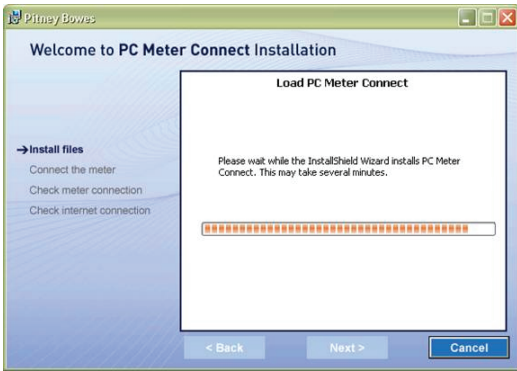

Screen 6

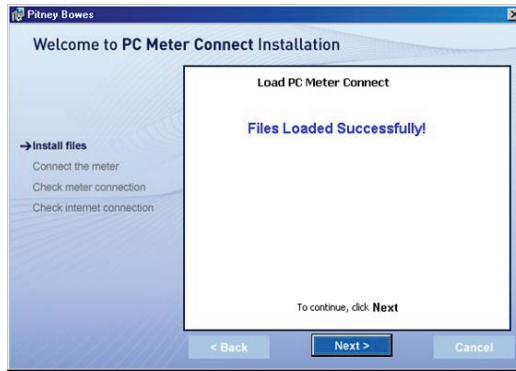

Screen 7

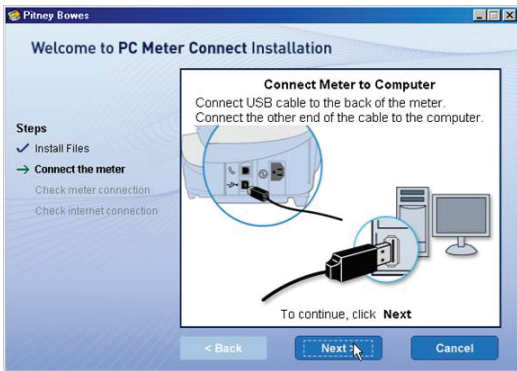

Screen 8

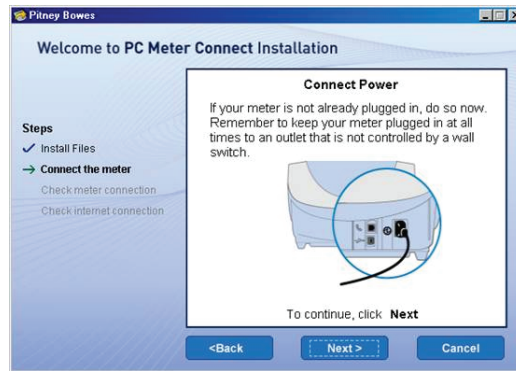

Screen 9



NOTE: You will now have an icon on your desktop and an icon down in your system tray.



2. Go to Step "4" to finish the install or select a different connection option.

Option 2: Setup Connectivity Using Constant Connection LAN Adapter

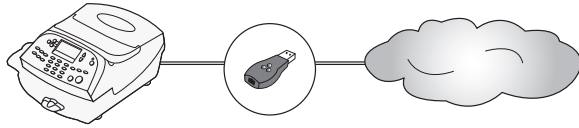

Constant Connection is an option that allows you to connect your DM125 system to the Pitney Bowes Data Centre via a LAN network that has internet access. Constant Connection provides faster transmission speed while connecting through your local network.

1. Be sure the meter is turned OFF. The ON-Off switch is located on the back of the meter.



2. Connect the short USB extension cable (approximately 6”) between the back of your meter, and the LAN adapter as shown. Make sure no cables are connected to the ports marked with a red X as indicated in the diagram.

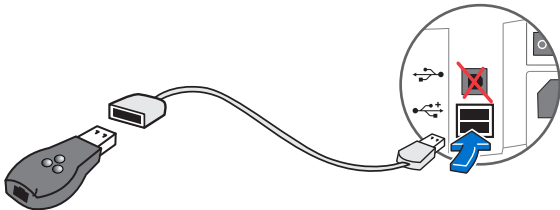

3. Plug one end of the Ethernet cable included in the kit into a network connection on the wall. Plug the other end of the Ethernet cable into the network adapter as shown and then proceed to step “4”.

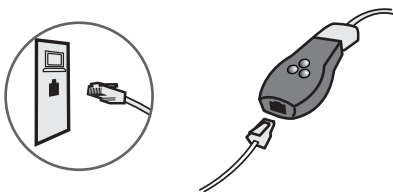

Step 4. Connect Power

1. Connect the power cord between the back of your meter and a convenient outlet.

i Keep the meter plugged in at all times to an outlet not controlled by a wall switch.

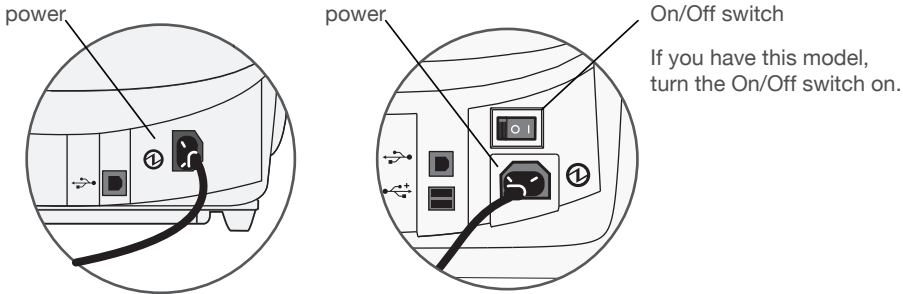

Step 5. Set Language and Time

1. After the system powers up and completes a self-check, select the language you wish to use. Simply press the small round button next to your choice.

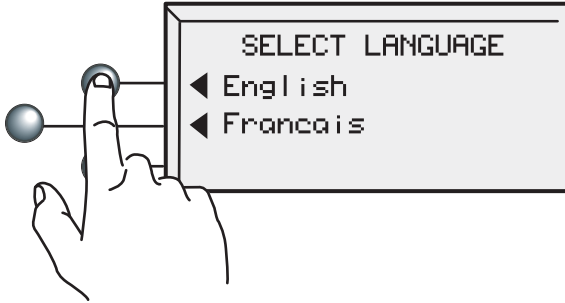

2. Your meter must be set to the correct local time.

If the hour value displayed (HH) is correct, select **OK and Continue**.

If the hour value is wrong, key in the correct value before pressing **OK and Continue**.



If the minutes value displayed (MM) is correct, select **OK and Continue**.

If the minutes value is wrong, key in the correct value before pressing **OK and Continue**.



3. Select AM or PM



Attention: You **MUST** set the AM/PM correctly. If the local time is off by 12 hours your system may print the wrong date on your mail and it may be returned by the Post Office.

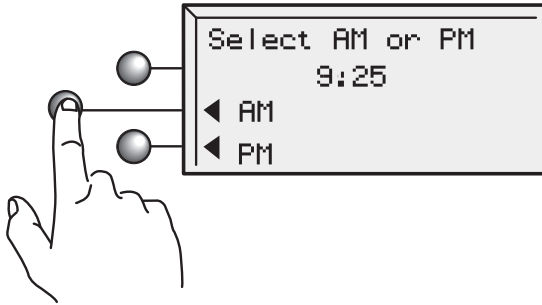

4. Check one last time, paying special attention to the AM/PM setting. If the current local time is correct, select **This is correct**.

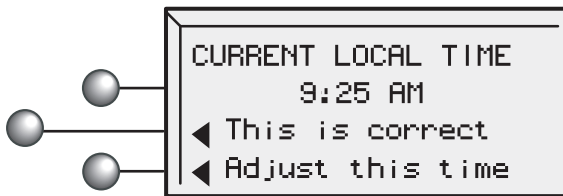

Step 6. Install the Print Head

1. The following screen should be displayed on your meter.

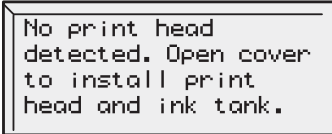

2. Open the top cover.

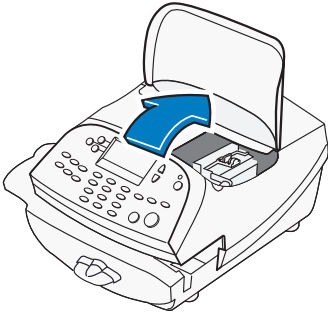

3. Unlatch and flip up the guard.

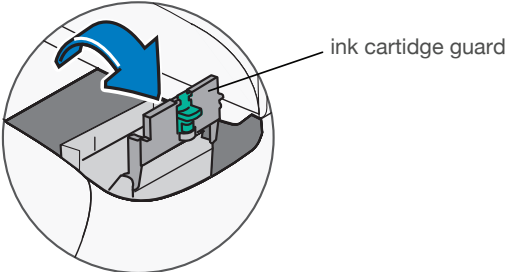

4. Remove the print head from the packaging.

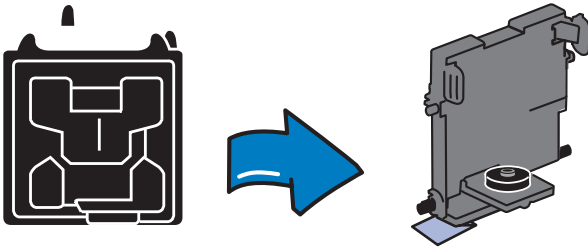

5. Remove the tape strip from the bottom of the printhead **or**
Remove the plastic cap from the bottom of the printhead, depending on the model.

 **Attention:** This step is critical to prevent system damage!

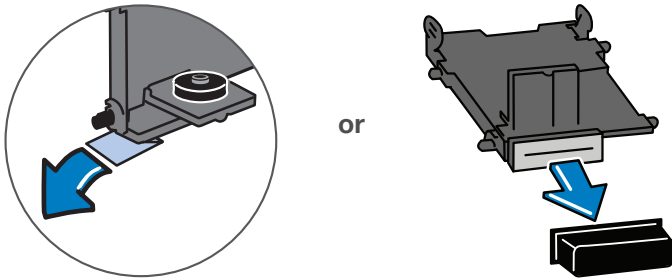

6. Slide the print head pegs into the lower set of grooves.

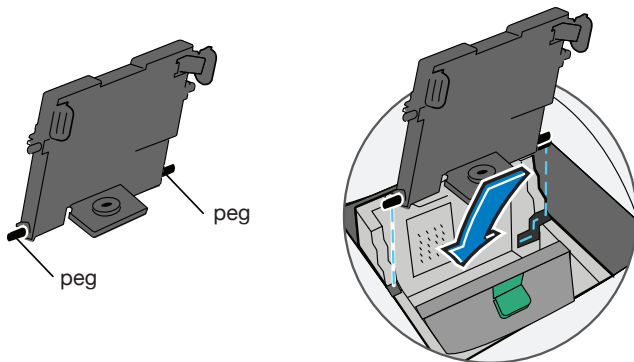

7. Squeeze the tabs and push the print head flush against the wall.

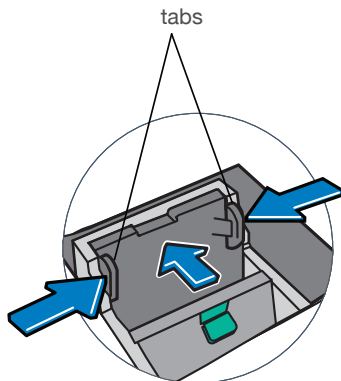

Step 7. Install the Pitney Bowes Ink Cartridge

1. Remove the ink cartridge from the bag. The silver foil strip on the bottom of the cartridge should remain in the bag when the cartridge is withdrawn.

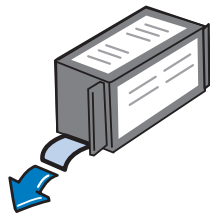

2. Drop the ink cartridge into the ink cartridge area, next to the print head. The label on the top of the cartridge should face front.

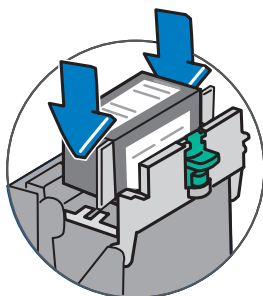

3. Close the guard until you hear a “click” to secure the ink cartridge.

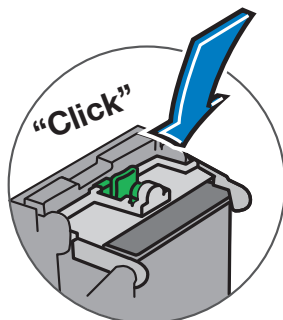

4. Close the top cover. The meter will automatically prepare the ink cartridge for use.



Step 8. Print a Test Pattern

1. When prompted, insert a spare envelope or a tape sheet for a test print.

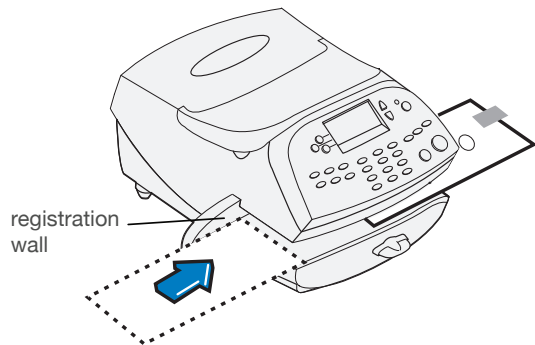

For proper printing, position mail flat against registration wall and gently slide test piece to the right on feed deck.

The system will detect the envelope and automatically feed it through the printing mechanism.

2. Determine if the quality of the test print is good by comparing it to the examples below.

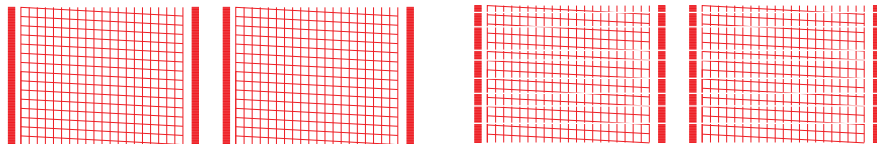

Good test print - no missing lines

Poor test print - missing lines

3. If the test print is **good**, press the green **Yes/Enter** key.
If the test print is **poor**, press the **No** key to perform additional maintenance.

Note: if you try maintenance 3 times and is still not correct please call 1-800-672-6937 and select options for technical support for help

No Yes/Enter



Step 9. Enter Scale Location Code

1. A scale code is needed to calibrate the scale. If you have just attached your scale, key in the correct scale code for your location. (Codes for each province can be found below). Then select Continue.

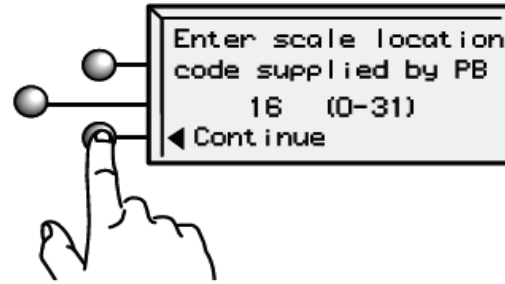

Scale Location Codes for Canada

Alberta		Nunavut	
Calgary	19	Iqaluit	26
Edmonton	21		
British Columbia		Ontario	
Vancouver	20	Ottawa	18
Victoria	20	Sudbury	18
		Thunder Bay	20
Manitoba		Toronto	17
Winnipeg	20	Windsor	16
New Brunswick		Prince Edward Island	
Moncton	19	Charlottetown	19
Saint John	18		
Newfoundland		Quebec	
Come by Chance	19	Charlesbourg	19
St. John's	19	Montreal	18
		Trois-Rivieres	19
North West Territories		Ville de Quebec	19
Yellowknife	25		
Nova Scotia		Saskatchewan	
Halifax	18	Moose Jaw	20
		Regina	20
		Saskatoon	21
		Yukon	
		Whitehorse	24

Step 10. Check Your Account Balance and Transfer Postage to Meter

 For your security, your meter does not ship with pre-loaded postage.

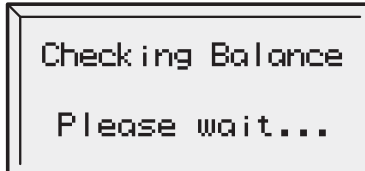

```
Checking Balance
Please wait...
```

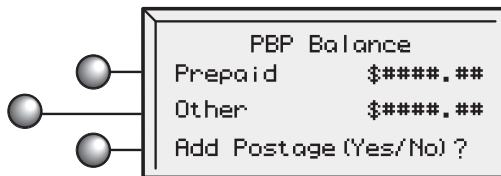

```
PBP Balance
Prepaid    $####.##
Other     $####.##
Add Postage (Yes/No) ?
```

PBP = Postage by Phone
It is simply your account balance.

1. When your account is accessed at the Postage-by-Phone® Data Centre, you will see your current balance (Prepaid) and your current credit line (Other). Some, or all, of the postage funds you have already purchased (Prepaid) you will transfer into your meter in the next step.

2. Select **Yes/Enter** to transfer postage into the meter.

No Yes/Enter



3. You will now transfer postage into the meter from your account. Key in the amount of postage you wish to add whole dollars only. (see funds report that was printed from old system in Step 1) If, when it connects, it gives an error message “**account not found**” please call **1-800-672-6937**, follow the prompts for PitneyWorks™



```
Enter amount of
postage to add.
  $#.00
◀ Continue
```

4. Select **Continue**.

```
CONFIRM ADD POSTAGE
Adding $****.00
(Yes or No)?
```

```
Adding Postage
Please Wait...
```

```
Transfer Successful
Added $****.00
Available $****.00
Receipt (Yes or No)
```

5. You will be asked to confirm your choice.
Press **Yes/Enter** or **No** for a receipt.

No Yes/Enter



6. Follow the screen prompts to print your receipt.

```
Please insert
envelope or tape
sheet to print
receipt.
```

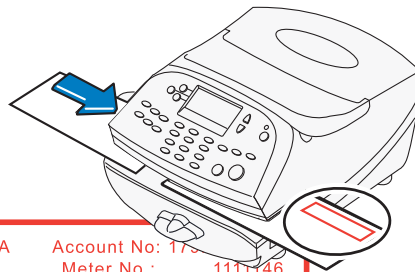

Refill Receipt	Refill: 16.04.21 11:38A	Account No: 17
	Refill Amount: \$100.000	Meter No.: 111146
	Funds Available in Meter: \$115.000	16.04.21
	Prepaid: \$935.780	11:38A
	Additional Funds Available: \$000.000	

Step 11. Last Step - Update Your Software

 This last step downloads current rates in addition to any additional features you may have ordered into your meter.

1. Select **Get update now**.

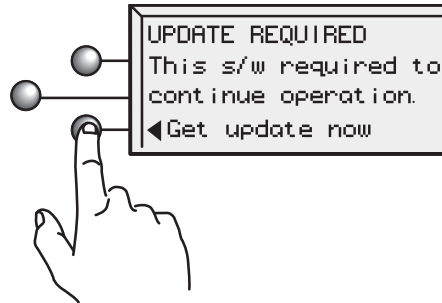

2. The updated files will be sent to, and installed on, your system. Follow the screen prompts.



3. When the software installation process has finished, select **Continue**.

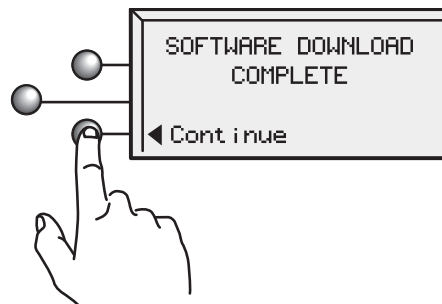

Congratulations!

Your Mailing System is Ready to Use

1. Select **OK**.

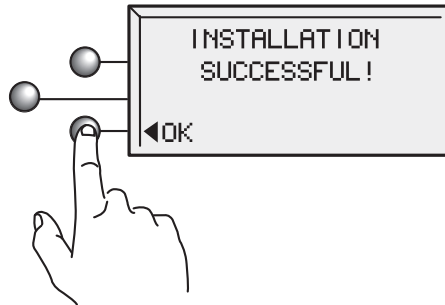

To customize your meter settings and learn all about using your system, see the **Operator Guide** on our WEB Site at: <http://www.pitneybowes.ca/support>. Follow the link for: Operating Guides.

If there are any further problems or questions please feel free to contact us at **1-800-672-6937** and follow prompts for Technical Support or e-mail us at: **Pbdiagnostics@pb.com**.

2. Follow the visual instructions on the next page for boxing up and sending back your old system.

Boxing Up and Sending Back Your Old System

You are now ready to box up your old system and ship it back using the provided return way-bill. Once equipment is packaged up, simply call the number on the back of the Prepaid waybill attached to the box.

NOTE: This is a prepaid transaction, so you will not incur any costs.

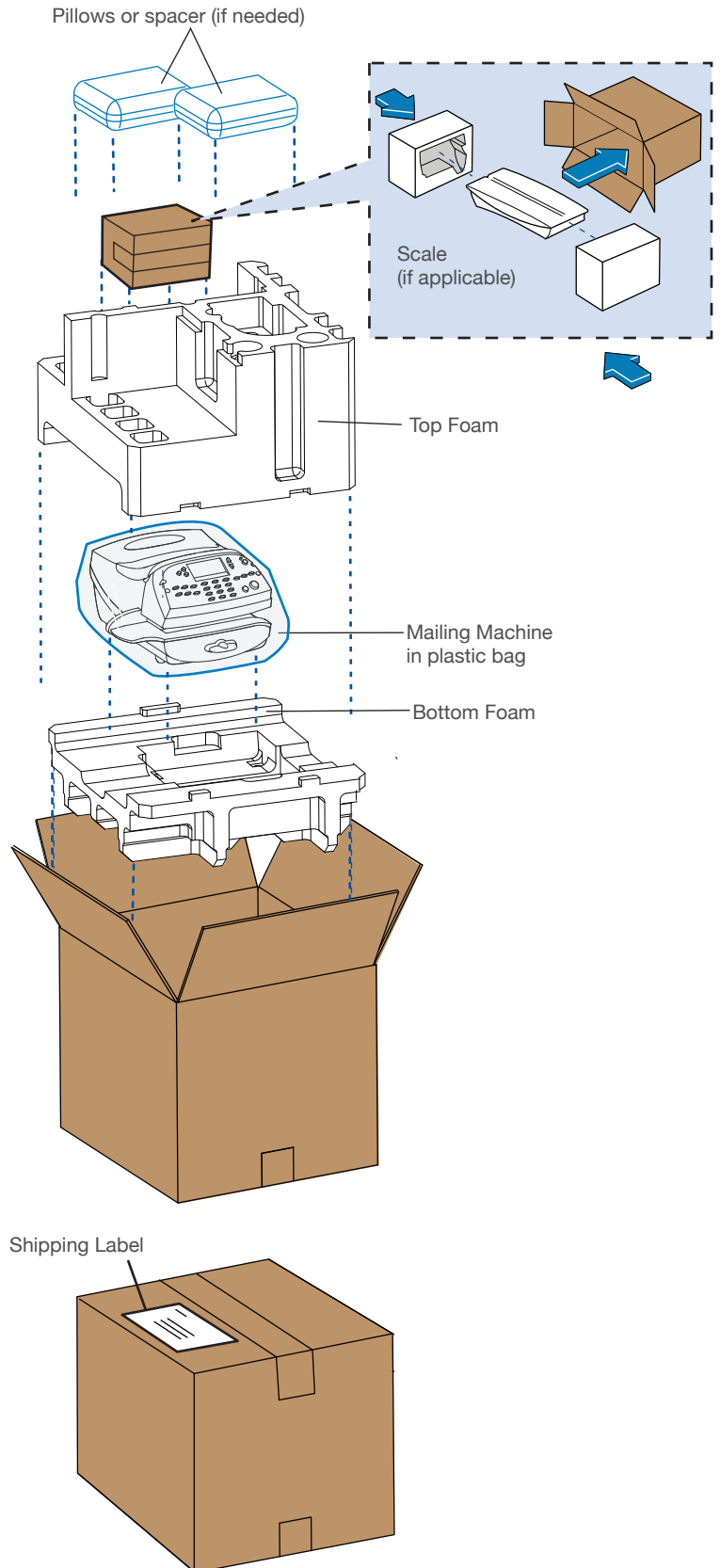

Frequently Asked Questions

What is PC Meter Connect?

PC Meter Connect is a small Desktop Application you install on your PC to allow your meter to connect to the Pitney Bowes Data Centre through your PC's Internet connection. Postage refills, and system software updates will be completed efficiently and much quicker via the Internet. The PC Meter Connect Desktop application and meter is certified as a system by ICSA Labs, an independent division of Verizon Business, which offers vendor-neutral testing and certification of security products. Many of the world's top security vendors submit their products for testing and certification at ICSA Labs. Businesses rely on ICSA Labs to authoritatively set and apply objective testing and certification criteria for measuring product compliance and reliability.

Visit <http://www.icsalabs.com> to learn more or review our certification at <http://www.pitneybowes.ca/support>.

How do I start up the PC Meter Connect Desktop Application?



You can start the PC Meter Connect software by double-clicking on the desktop icon placed on your Windows desktop during the installation process. Double-clicking places a much smaller PC Meter Connect icon in your Windows system tray at the bottom of your screen. PC Meter Connect is now running and you may connect to the Pitney Bowes Data Centre. Alternately, you may click on the Start button >> All Programs >> Pitney Bowes >> PC Meter Connect.

How do I know PC Meter Connect is running?



The small system tray icon will be visible whenever PC Meter Connect is running.

Where is my PC Meter Connect Desktop Application?

The latest PC Meter Connect Desktop Application can be found at www.pitneybowes.ca/support

Why must I add postage to my meter?

For your safety, and to prevent any unauthorized use, your meter is shipped without money in it. Postage is refilled through PitneyWorks®. Information about PitneyWorks® can be found at <http://www.pitneyworks.ca>

What is a scale location code?

The accuracy of any scale is affected by its geographic location on the earth (how far it is from the Equator) and its altitude above sea level. The scale location code provided by Pitney Bowes helps calibrate the scale to be as accurate as possible for your particular location.

Where is my Operator Guide?

The latest Operator Guide can be found using the Support URLs listed below. The guide is in Adobe PDF format, so you may easily view it and print out individual sections or the entire guide as you wish.

For product support go to: <http://www.pitneybowes.ca/support>

Product Name: Model DM125

Troubleshooting

Checking Connectivity Using Constant Connection LAN Adapter

Turn the meter ON. Once the meter has finished initializing and the Home screen is displayed, one of the small LED indicators on the LAN adapter should light up within 1 minute. If none of the LED indicators light up, refer to additional information below.

None of my Link LED indicators are ON; Adapter is not working

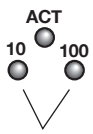

Either the 10 or 100 LINK LED indicators should be ON (solid green), indicating your connection's data transfer rate. If neither of these LED indicators are ON, check the following items:

1. Verify the LAN cable, LAN extension cable, and LAN adapter are properly installed and plugged firmly into their receptacles.
2. Turn OFF the meter using the ON-OFF switch, wait 10 seconds, and turn ON the meter.
3. Repeat steps 1 and 2 using the other USB port on the meter.
4. Ensure that no telephone cord is connected to the meter when the LAN is installed.
5. Ensure that no PC having PC Meter Connect software is connected to the meter when the LAN is installed.

If you experience difficulty connecting to the PB Data Center, refer to the tips below for further assistance. If necessary, have your network administrator review the Troubleshooting tips and the separate IntelliLink™ Control Center Technical Support Configuration Guide to resolve the issue. The information is available on our support site at <http://www.pitneybowes.ca/support>.

Not Enough Funds

You have tried to add more postage to your meter than you have in your account at PitneyWorks.

To Change Information Entered during the Install Procedure

1. Press Clear key on numeric keypad.
2. At Install Not Complete, either go back to the previous step or start the installation procedure over again.

To Change Selection after the Setup Program is Complete

1. Press the Options key.
2. Press the green Page Down button twice.
3. Select Advanced Features.
4. Press Page Down.
5. Select Run Install Mode.

Technical Support

Still have questions?

For installation support call: **1-800-672-6937**. Alternately, your questions may be answered in the Operator Guide or online.

The Operator Guide can be found at the following websites: <http://www.pitneybowes.ca/support>

Product Name: **DM100i Model:** P7EC

Product Name: **DM125 Model:** PREC

If there are any further problems or questions please feel free to contact us at **1-800-672-6937** and follow the prompts for Technical Support or e-mail us at: **Pbdiagnostics@pb.com**.